

SIEMENS

*Optiset E Standard, Advance,
and Advance Plus*

Quick Reference Guide

NOTE: This equipment has been tested and found to comply with the limits for a Class B digital device, pursuant to Part 15 of the FCC Rules. These limits are designed to provide reasonable protection against harmful interference in a residential installation. This equipment generates, uses and can radiate radio frequency energy and, if not installed and used in accordance with the instructions, may cause harmful interference to radio communications. However, there is no guarantee that interference will not occur in a particular installation. If this equipment does cause harmful interference to radio or television reception, which can be determined by turning the equipment off and on, the user is encouraged to try to correct the interference by one or more of the following measures:

- Reorient or relocate the receiving antenna.
- Increase the separation between the equipment and receiver.
- Connect the equipment into an outlet on a circuit different from that to which the receiver is connected.
- Consult the dealer or an experienced radio/TV technician for help.

WARNING: Changes or modifications to the equipment that are not expressly approved by the responsible party for compliance could void the user's authority to operate the equipment.

This equipment does not exceed Class B limits per radio noise emissions for digital apparatus, set out in the Radio Interference Regulation of the Canadian Department of Communications. Operation in a residential area may cause unacceptable interference to radio and TV reception requiring the owner or operator to take whatever steps are necessary to correct the interference.

Cet équipement ne dépasse pas les limites de Classe B d'émission de bruits radioélectriques par les appareils numériques, telles que prescrites par le Règlement sur le brouillage radioélectrique établi par le ministère des Communications du Canada. L'exploitation faite en milieu résidentiel peut entraîner le brouillage des réceptions radio et télé, ce qui obligerait le propriétaire ou l'opérateur à prendre les dispositions nécessaires pour en éliminer les causes.

June 1997

Form No. GU30-1604-00 Part No. 06D8631 EC No. A92946

No part of this publication may be reproduced, stored in a retrieval system, or transmitted, in any form or by any means, mechanical, electronic, photocopying, recording, or otherwise, without prior written permission of Siemens Business Communication Systems, Inc.

Request Siemens publications from your Siemens representative or the Siemens branch serving you. Publications are *not* stocked at the address below.

Siemens Business Communication Systems, Inc.

4900 Old Ironsides Drive

P.O. Box 58075

Santa Clara, CA 95052-8075

(408) 492-2000

TWX: 9103387350 ROLM SNTA B Telex: 278156 ROLM UR

Siemens and Hicom are registered trademarks of Siemens Aktiengesellschaft. Optiset and PhoneMail are registered trademarks and OptiGuide is a trademark of Siemens Business Communication Systems, Inc.

Copyright Siemens Business Communication Systems, Inc. 1997.

All rights reserved.

Contents

Welcome to Your Optiset E Standard, Advance, or Advance Plus Telephone	1
Optiset E Standard Telephone	2
Optiset E Advance and Advance Plus Telephones	3
Bay Option Modules	4
Optiset E Key Module	7
Optiset E Local Power Supply	8
Where to Go for Assistance	9
Your Class of Service	9
Line Keys	9
Status Lights	9
The OptiGuide Display	10
Feature Keys and Access Codes	14
Volume Keys	14
Changing Your Audio Settings	15
Callback Request	16
Conference	17
Connect	18
Consultation	19
Forwarding	20
Hold	21
Last Number Redial	22
Mailbox	23
Park	24
Pickup	25
Pick A Call and Add to Conference	26
Repertory Dialing (Repdial) Keys	27
Saved Number Redial	28
Speaker	29
Speakerphone	29
Station Speed Dialing	30
System Speed Dialing	32
Transfer	33
Feature Access Codes	34

Welcome to Your Optiset E Standard, Advance, or Advance Plus Telephone

The Optiset[®] E Standard, Advance, and Advance Plus digital telephones work with your company's Siemens[®] Hicom[®] 300 E Communications Server to give you advanced, easy-to-use telephone features. The communications server is your facility's internal telecommunications system.

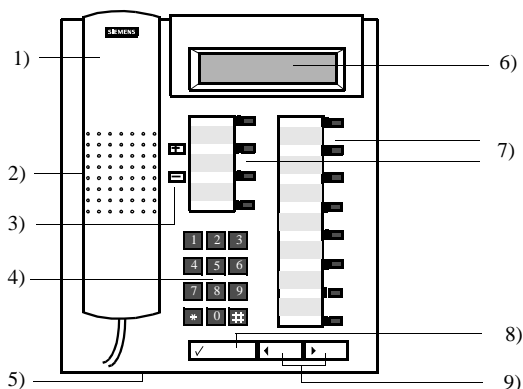

**Figure 1. Optiset E Standard, Advance, Advance Plus
Telephones**

- 1) Handset
- 2) Speaker (ringing tone/open listening)
- 3) Keys for telephone settings
- 4) Key pad
- 5) Microphone for handsfree talking
(for Optiset E Standard and Advance Plus)
- 6) Display with 2 lines, 24 characters each
(for Optiset E Standard, Advance, and Ad-
vance Plus)
- 7) Feature keys with status lights
- 8) Guidance key "Select" (confirms function)
- 9) Guidance keys "Scroll Forward" and
"Scroll Back" for browsing

Optiset E Standard Telephone

The Optiset E Standard telephone has a microphone for a two-way speakerphone and does not support user-installable option modules.

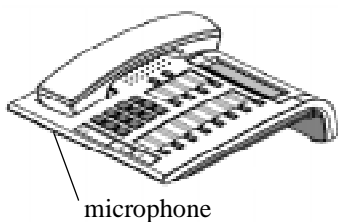

Figure 2. Optiset E Standard Telephone

Optiset E Advance and Advance Plus Telephones

The Optiset E Advance and Advance Plus telephones have two bays, underneath their bases, that support the following user-installable option modules:

- the Optiset E Analog Adapter
- the Optiset E Data Adapter
- the Optiset E Headset Adapter
- the Optiset E Headset Plus Adapter
- the Optiset E ISDN Adapter
- the Optiset E Phone Adapter

These phones also support up to four, side-mounted Optiset E Key Module options, for a total of 64 additional feature keys and up to 29 line extensions. The Optiset E Advance Plus telephone also has a microphone for a two-way speakerphone.

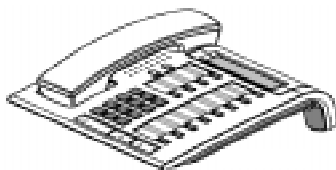

Figure 3. Optiset E Advance Telephone

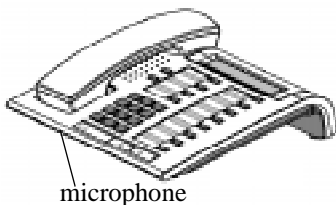

Figure 4. Optiset E Advance Plus Telephone

Bay Option Modules

The bay option modules snap into place in the bays underneath the Advance and Advance Plus phones. They are the same size and shape, but labels clearly identify their type.



Figure 5. Bay Option Modules

Optiset E Analog Adapter

The Analog Adapter lets you attach a standard analog device, such as a phone, facsimile machine, modem, or answering machine, to your phone via an RJ11 connector on the back of the adapter. The attached device is configured at your communications server to be completely independent, with its own phone number. It can be attached to a standard telephone cable up to 300 ft. long. This adapter requires the Optiset E Local Power Supply for operation. (See “Optiset E Local Power Supply” on page 8.)

Optiset E Data Adapter

The Data Adapter lets you connect your phone to a computer or terminal via a 25-pin connector for an EIA-232-E cable. You can make asynchronous data calls by issuing AT commands from your attached PC or terminal to your phone, much as you would to an attached modem. This adapter supports baud rates of up to 38.4 kilobytes per second (autobaud detection), simultaneous voice and data communication, hardware flow control (RTS/CTS) and full duplex operation. It also supports the Siemens Application Programming Interface (API), data loopback for customer service tests, and V.120 and DMI mode 2-Bit Rate Adaptation.

Optiset E Headset Adapter

The Headset Adapter lets you plug one or two electret microphone-type headsets into your phone. You can then make and answer calls using a headset instead of the handset or the phone’s built-in microphone and speaker. This type of headset does not require an amplifier. Connection is made through two

RJ8 connectors. Only the Optiset E Advance and Advance Plus telephones support this option. When a headset is plugged into the option, the speakerphone in the Optiset E Advance Plus telephones does not function.

Optiset E Headset Plus Adapter

The Optiset E Headset Plus Adapter lets you plug one or two carbon microphone-type headsets and a recorder into your phone. You can then make and answer calls using a headset instead of the handset or the phone's built-in microphone and speaker.

This type of headset requires an amplifier. You can also record your conversations. The headsets attach to two RJ8 connectors. The recorder attaches to an RJ11 connector. Only the Optiset E Advance and Advance Plus telephones support this option. When a headset is plugged into the option, the speakerphone in the Optiset E Advance Plus telephones does not function. This adapter does not have a two-prong PJ327 adapter interface. The recorder works without a headset being plugged in.

Optiset E ISDN Adapter

The ISDN Adapter lets you connect ISDN S0 bus devices such as phones, PC cards, LAN Bridges, G4 fax machines, and video equipment to your phone via an RJ45 connector. It supports up to 64 kilobytes per second simultaneously on each bearer channel. It will only work properly in a primary phone, not in a phone attached to another phone with the Phone Adapter. You can only connect two ISDN devices to the adapter.

Optiset E Phone Adapter

The Phone Adapter lets you attach another Optiset E phone to your Basic phone. It provides an RJ11 connector to which you can attach the second phone via a standard telephone cable up to 300 feet long. You can then place the second phone in an area not wired for a phone. The attached phone is configured at your communications server to be a completely independent phone with its own phone number.

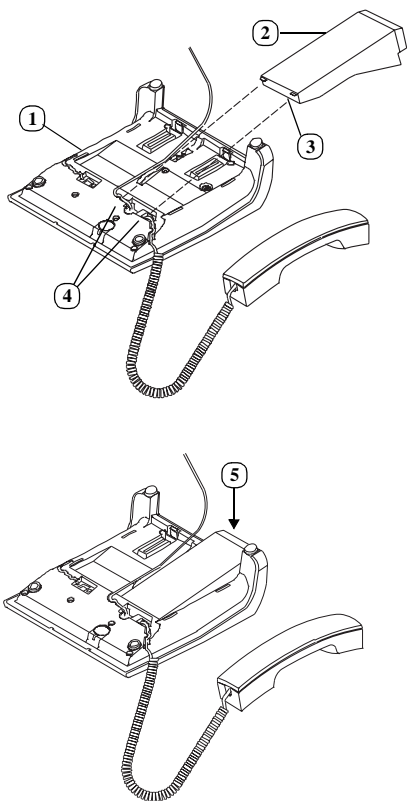

Figure 6. Installation of Bay Option Modules

1. Disconnect the phone line from the wall jack or phone and place the phone ① on a soft surface with the keypad facing down.
2. Hold the adapter ② with the male connector strip facing down and mount it in one of the two mounting locations on the bottom of the phone, sliding the two tabs ③ into the two slots ④.
3. Gently press down on the adapter until the male connector strip is inserted all the way into the female connector strip ⑤.

For the **Analog Adapter**, connect an analog device to the 6-pin RJ11 port on the back of the Analog Adapter (connecting tip/ring to pins 3 and 4). Reconnect the phone line to the phone. Note that the analog adapter requires the Optiset E Local Power Supply for operation.

For the **Data Adapter**, connect the data terminal equipment to the 25-pin (EIA232) connector on the back of the Data Adapter. Reconnect the phone line to the phone.

For the **Headset Adapter**, connect the headset(s) to the headset (RJ8) connector(s) on the adapter. Reconnect the phone line to the phone.

For the **Headset Plus Adapter**, connect the headset(s) to the headset (RJ8) connector(s) on the adapter. Connect the recorder to the recorder (RJ11) connector. Reconnect the phone line to the phone.

For the **ISDN Adapter**, connect the ISDN terminal to the RJ45 adapter. Reconnect the phone line to the phone.

For the **Phone adapter**, connect the secondary Optiset E phone into the RJ11 connector on the adapter. Reconnect the phone line to the phone.

Optiset E Key Module

The side-mounted Optiset E Key Module adds 16 keys for features and line extensions. Up to four Optiset E Key Modules can be linked together on one phone, for a total of 64 additional feature keys and up to 29 line extensions. Only the Optiset E Advance and Advance Plus telephones support this option. Wall mount kits do not support phones with an Optiset E Key Module attached.

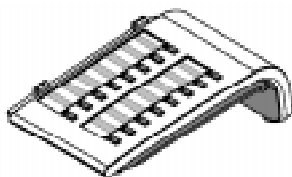



Figure 7. Optiset E Key Module

Optiset E Local Power Supply

The Local Power Supply is required for the Analog Adapter. It may also be required in other situations, depending on the Optiset E telephone's configuration, the type of phone cable used, the length of the phone cable from the communications server, and the type of communications server used. Only one Optiset E Local Power Supply can be used at a time on an Optiset E phone. However, one Local Power Supply can be used on a primary phone and a second Local Power Supply can be used on a secondary phone attached to the primary phone through a Phone Adapter.

Installation of Local Power Supply

To install a local power supply:

1. Disconnect the phone line from the wall jack. New phones should have a line cord attached to the phone, but may not be plugged into the wall jack. Plug the line cord ① running from the phone into the jack on the power supply labeled  .
2. Plug one end ② of the additional line cord that came with the power supply into the jack labeled  .
3. Plug the other end ③ of the additional line cord into the wall jack, or into the Optiset E Phone Adapter installed in another phone.
4. Plug the power supply ④ into a properly grounded 120 VAC electrical outlet.

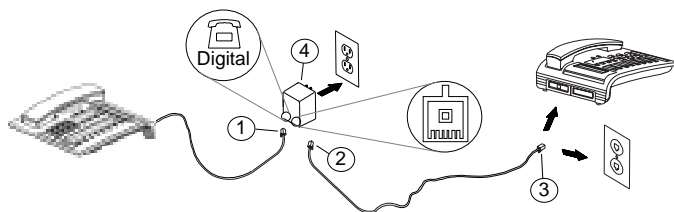

Where to Go for Assistance

Although every company has its own way of handling support for Optiset E telephones, most have a person responsible for making configuration changes and answering questions about the telephone system. This person, the system administrator, can provide you with information on the features you need to use and can help troubleshoot problems with your phone when necessary. For more detailed information about your phone's features and operation, refer to the *Optiset E Entry, Basic, Standard, Advance, and Advance Plus Administrator Guide for Hicom 300 E CS (GU30-1602-00)*.

Your Class of Service

Each phone in your Siemens telephone system has a class of service (COS) that specifies the features available to it. Therefore, you may find that some features included in this guide are not available on your telephone. Ask your system administrator which features have been assigned to your telephone.

Line Keys

Your Optiset E telephone has a separate line key for every extension that appears on your phone. You use the line keys to answer and place calls.

Status Lights

The red status lights next to the line keys tell you what is happening on those lines. A line key status light may turn on steadily, blink, or flash at different rates to signal the status of that line.

When the light is...	the line is...
Off	Available
On steady	In use
Blinking	Ringing
Flashing (faster)	On hold
Flickering (fastest)	Forwarded

The OptiGuide Display



The OptiGuide™ display provides information to help you use your phone. The top line, generally in all capital letters, shows the time and date and call-related information like the extension calling you.

The second line, in initial capital letters, indicates some of the features available to your phone in its current state and provides prompts on how to use them. For example, when you are on a call, the prompt *Start transfer?* appears, to let you transfer the call if you want. When the > symbol appears at the right of the display, more features are available for your phone's current state. The second line also presents call-related information. You can configure your phone to display this line automatically or manually. (See *Configure display?* on page 13.)

You can also use the OptiGuide display to show features you have activated, scroll through messages sent to your phone, and change the audio settings on your phone.



Guidance Keys



The three large keys at the bottom of the phone are used to scroll through prompts and select features.

- The  key (Scroll Forward) is used to scroll to the next option.
- The  key (Scroll Back) is used to scroll to the previous option.
- The  key (Select) is used to select or start the displayed feature or function.

After you have selected a feature, new prompts appear which help you complete the feature's operation.

Main Menu

To go to the main menu, press the Menu key. If your phone is idle, you can also press  or . (This manual assumes that a Menu key has been set up for the user's phone at the communications server.)

Then use  or  to scroll to any of the following prompts, which vary in some cases, depending on whether your phone is idle or active (when you have a dial tone or are on a call):

- *Speed dial features?*
- *More features?*
- *View active features?*

- *Program/Service?* (only available from the idle state)
- *Audio settings?* (only available from the idle state)

Speed dial features? provides access to:

- *Last number redial?* - to redial the last number you dialed.
- *Station speed dial?* - to set up single digit codes to dial frequently used dialing sequences.
- *Saved number redial?* - to redial a number you have saved.
- *System speed dial?* - to use codes set up at your communications server to dial frequently used dialing sequences. You may have two system speed dial lists.

More features? provides access to prompts not available for activation through other prompts. If your phone is idle, the following prompts appear:

- *Call forwarding?* - to forward calls to another extension or outside number.
- *Do not disturb?* - to block incoming calls.

If your phone is active, a different set of prompts appears:

- *Enter account code?* - to enter a code to charge an external call to an account.
- *Time and date?* - to display the time and date, when your phone is active.
- *Open listen/speaker?* - to use your handset and let someone nearby listen to the conversation over the speaker at the same time (on a phone with a speakerphone).
- *Private hold?* - to place a call in a temporary waiting position from which it can be retrieved only from your phone.
- *Line in-use?* - to determine which extension line you are currently using.
- *Mark bad line?* - to report a bad connection with an external call, so that it is logged at the communications server.

View active features? lets you view the features you have activated on your phone and lets you deactivate them. From it, you can scroll through submenus that show the state of the following features:

- FWD-ALL-BOTH - to forward both internal and external calls under all conditions.
- Do Not Disturb - to block incoming calls.
- Hunt Group - to show whether you are actively part of a hunt group that automatically moves a call to the first

available member extension.

- Speaker Call Rejection - to block incoming speaker calls.
- Call Waiting Terminate - to immediately alert you with a tone when a caller is trying to reach you with Busy Standby Queuing.
- Callback - to show whether you have a callback request pending to help you reach another extension.

Program/Service? This is only available from the idle state and can be reached by pressing the Program key. The Program/Service menu gives you access to the following submenus:

- *Change destinations?* - to create or change destinations for the following features:
 - Call Forwarding - to forward calls to another extension or outside number.
 - Redials - to set up keys for one-touch dialing.
 - Station Speed Dial - to assign frequently used dialing sequences to codes for easy dialing.
 - Saved Number Redial - to redial a number you have saved.
 - Direct Station Select (DSS) - to monitor and automatically dial or answer an extension.
- *Feature settings?* - to display and activate or deactivate the following features:
 - Call Forwarding - to forward calls to another extension or outside number.
 - Do Not Disturb - to block incoming calls.
 - Stop Hunt - to use the No-Hunt feature to remove your phone from a Hunt group. A Hunt group is a group of phones that move an incoming call from one member's phone to another until it is answered or the caller hangs up.
 - Speaker Call Rejection - to block incoming speaker calls.
 - Call Waiting Terminate - to immediately alert you with a tone when a caller is trying to reach you with Busy Standby Queuing.

- View Callbacks Sent - to show whether you have sent a callback request to help you reach another extension.
- *Mailbox?* - to scroll through the PhoneMail and reminder messages that have been left on your phone and view the author, date, and time of the message. (You can also press the Mailbox key, if one appears on your phone, to reach the *Mailbox?* prompt.) It takes you to the following submenus:
 - All messages?
 - PhoneMail messages?
 - Reminder messages?
- *View feature keys?* - to display the feature keys configured on your phone. It prompts you to press the key whose function you wish to display.
- *Audio settings?* - to adjust the following audio settings for your phone:
 - Ring volume
 - Ring tone
 - Alert tone volume
 - Speakerphone mode - to remove echoing from your speakerphone.
- *Configure display?* - to configure your phone for automatic or manual presentation of features prompts on the second display line when you are on a call. If you choose manual, push the right or left arrow keys to display prompts.
- *Phone test?* - to test the followings aspects of your phone:
 - LED?
 - Display
 - Key
 - Audio tests
 - Asset ID - to show the phone's unique number.
 - Firmware version - to show the firmware version of the phone.
 - Power level - to show whether a Local Power Supply is needed for your phone.

You can press the Program key, if one appears on your phone, to reach the Program/Service? prompt.

Also notice the service code numbers in the lower left of the subprompts available through the Program/Service prompts.

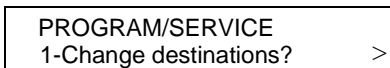





From the Program/Service prompt, you can dial these numbers to go directly to these submenus. Similarly, the subsections within the submenus have numerals that you can dial to go to those subsections.



Audio Settings? (also available from the Program/Service menu) lets you adjust the following audio settings for your phone: ring volume, ring tone, alert tone volume, and speakerphone mode.

Feature Keys and Access Codes

You can also press feature keys to gain access to Siemens telephone system features such as Hold, Transfer, Mailbox, and Program. Since your phone has already been assigned a set of feature keys, it may not have some of the feature keys described here. However, you may still use any feature available on your system and permitted by your class of service by dialing its feature access code, if it has one. This guide explains the basic steps for using many features, including the default feature access codes. Your system administrator may have configured both the acronyms for feature keys and the access codes differently from how they appear here.









Volume Keys

Use the Volume Up  and Volume Down  keys to adjust the voice volume of your telephone. While on a call, press  to raise the volume of the voice you are hearing, or press  to lower it. Press either key until you reach the desired voice level. Holding down either key only changes the volume one step.

When you hang up or switch to another call, the voice volume returns to the default level. Or you can store the new setting to override the default setting before hanging up, by pressing the  (Select) key or by pressing the  and  keys together, before you hang up.

Changing Your Audio Settings

To change the audio settings on your phone:

1. From the Program/Service menu or the Main menu in the idle state, select *Audio settings?*.
2. Press the  key to go to the audio setting you want to change. Press the  key if you want to go back to a previous audio setting.
3. Press the  key. Your phone will display the current setting for the audio setting you have selected. It will also make the sound of the current setting for ring volume, ring tone, and alert tone.
4. If you want to exit without making changes, hang up or press #.
5. To adjust the setting higher or lower, press the  or  keys. For ring volume, ring tone, and alert tone, your phone will make the sound of the adjustment.
6. If you want to exit without making changes, hang up or press #.
7. To save the adjustment you have made, press the  key. Or press the  and  keys together.

Callback Request

Callback Request has the communications server help you complete calls to extensions that are busy, ringing, or in Do Not Disturb mode. It lets you hang up and have the communications server call you back with triple rings. When you then answer, the communications server automatically dials the number.

To request a callback,

1. Listen for the phone to ring or for the busy signal.
2. Select *Callback?* on your OptiGuide display.

Or press the Callback (CALLBCK) key, or dial # 1.

3. Hang up.
4. When the communications server calls back with triple rings, answer. The communications server will then dial the extension.

Conference

The Conference feature lets you have up to eight parties, including yourself, in a telephone conversation. The other parties besides yourself can be on trunks (outside lines).

To set up a conference,

1. During a call, scroll through the prompts on your OptiGuide display and select *Start conference?*.

Or press the Transfer (TRANSFR) key.

2. Dial the extension you want to add, or dial 9 and the outside number.
3. After the party answers, select *Conference?* from your OptiGuide display to join all the parties.

Or press the Conference (CONF) key (or TRANSFR).

To reconnect to the conference when a called party isn't joining,

Scroll through the prompts on your OptiGuide display and select *Release and return?*.

Or press the Connect key.

To drop the last added party,

Scroll through the prompts on your OptiGuide display and select *Remove last party?*.

Or press the Clear key, or press TRANSFR and dial * * * 4. Then press the Conference (CONF) key (or the Connect key or TRANSFR) to rejoin the conference.

Connect

Connect lets you

- reconnect with a call placed on consultation hold
- reconnect with a transferred call before the transfer is complete
- alternate between two parties, when you have one of them on consultation hold

To reconnect with a call,

Scroll through the prompts on your OptiGuide display and select *Toggle/Connect?*

Or press the Connect key.

Consultation

Consultation lets you put the other party in a call on consultation hold, so that you can call and talk privately with a second party. You can then use the Connect feature to alternate between the two parties.

To consult with a second party during a call,

1. Scroll through the prompts on your OptiGuide display and select *Consult?*.

Or press the Transfer (TRANSFR) key.

2. Dial the second party's extension or 9 and the outside number.
3. Talk with the second party.

To reconnect with the first party,

Scroll through the prompts on your OptiGuide display and select *Toggle/Connect?*.

Or press the Connect key.

You can continue to use the Connect feature to alternate between the two parties.

To release a party on consultation hold,

While connected with the party, scroll through the prompts on your OptiGuide display and select *Release and return?*.

Or press the Clear key.

The party will be released, and you will be connected to the other party.

Forwarding

Forwarding redirects your incoming calls to another extension or an outside number. Variable Forwarding lets you set up an extension or outside number for forwarding under conditions you specify. Fixed Forwarding sends calls to extensions set up for you at the communications server.

To use Variable Forwarding for all calls under all conditions,

1. When your phone is idle, press the Menu key.
2. Scroll to *More features?* and select it.
3. Scroll to *Call forwarding?* and select it.
FWD-ALL-BOTH - - - OFF is displayed.
4. Dial the number where you want your calls forwarded.

OR

Get a dial tone. Press the Forward key or dial # 91. Dial the extension, or 9 and the outside number, where you want your calls forwarded. Hang up.

To cancel Variable Forwarding,

1. When your phone is idle, press the Menu key.
2. Use the OptiGuide display to scroll to *More features?* and select it.
3. Select *Call forwarding?*.
FWD-ALL-BOTH - - - ON is displayed.
4. Scroll to *Deactivate?* and select it.

OR

Press the Forward key, or get a dial tone and dial # # 9 1, and then hang up.

To cancel Fixed Forwarding,

Get a dial tone and dial # # 9 0.

To restore Fixed Forwarding,

Get a dial tone and dial # 9 0.

Hold

The Hold feature lets you hang up a line without disconnecting the other party. If you do not retrieve the call after a certain period of time (determined by the communications server), your phone will ring. If it is an external call and you do not answer, the call is transferred to the operator.

If you want to make another call after placing a call on hold, you must use another line. If your telephone has only one line, press the Transfer (TRANSFR) key, instead of the Hold key, to place the call on consultation hold, then dial the second party.

To put a call on hold,

Use the OptiGuide display to scroll to *Hold?* and select it.

Or press the Hold key.

To reconnect,

Press the line key next to the flashing status light, or pick up the handset and press the line key.

Last Number Redial

Last Number Redial lets you quickly redial the last number you have dialed. Each time you dial a valid internal or external telephone number it is automatically stored so that you can redial it later. Numbers dialed during consultation calls and transfers are also stored. Only one number is stored at a time, and once you dial a new number it replaces the number stored previously.

To redial the last number dialed,

1. When your phone is idle, press the Menu key.
2. Select *Speed dial features?*.
3. Select *Last number redial?*.

OR

Press the Last Number Redial (LNR) key.

OR

Get a dial tone and dial # # 4.

Mailbox

This feature lets you receive and answer PhoneMail® messages and reminder messages left on your phone by internal callers. Messages turn on the status light beside your Mailbox key and (on display phones) provide information about the call. If you have a PhoneMail key, PhoneMail messages turn on the status light beside it instead. The Mailbox key also lets you leave reminder messages at other internal extensions.

To display messages,

1. When your phone is idle, press the Menu key.
2. Scroll to *Program/Service?* and select it.
3. Scroll to *Mailbox?* and select it.
4. Select *All messages?* or *Phonemail messages?* or *Reminder messages?*.
The caller's extension and the date and time of the call will be displayed.
5. To display any additional messages, scroll to *Next entry?* and select it.
6. To delete a displayed message, scroll to *Delete?* and select it.

To answer a displayed message,

Scroll to *Call originator?* and select it.

The communications server calls back the party or system that left the message. (It can call a voicemail system or another number configured at the communications server.) When the party or system answers, the message is deleted.

To leave a reminder message,

When you make a call and receive a busy tone or no answer, scroll to *Reminder message?* and select it.

The other party's Mailbox status light turns on. If the other party has a display phone, the system will also leave a reminder message providing your name and the date and time of your call.

Park

Park lets you move a call to an extension and hold it there without ringing that extension. You or another party can then retrieve the call from the extension as needed.

To park a call to another extension,

1. Scroll to *Park call?* and select it.
2. Dial the extension where you want to park the call.
3. Hang up.

OR

Press the Transfer (TRANSFR) key. Dial * 6. Dial the extension where you want to park the call. Hang up.

To retrieve a parked call,

If the extension is on your phone, press the line key next to the flashing status light.

If the extension is on another phone,

1. Press the Pickup key.

Or get a dial tone and dial * 3.

2. Dial the extension where the call is parked.

Pickup

Pickup features let you answer calls ringing, on hold, queued, or parked at other extensions.

Group Pickup lets you answer a call to an extension in your pickup group (set up at the communications server) even when you do not know the number for the extension.

Station Pickup lets you answer a call at any extension, provided that you know the number for the extension.

To answer a call in your pickup group,

Press the Pickup key twice. Or get a dial tone and dial * * 3.

To answer a call ringing, on hold, queued, or parked at any extension,

1. Press the Pickup key, or get a dial tone and dial * 3.
2. Dial the extension.

Pick A Call and Add to Conference

You can use the Pickup feature to pick up the following kinds of calls and add them to a conference call.

- a call alerting or ringing on another extension, on your phone or other phones
- a call on hold on another line, on your phone or another phone
- a call parked on another extension
- a call on busy standby queuing for another extension
- a call on busy standby queuing for the line that you are using

To pick a call and add it to a conference,

1. Press the Pickup key during a two-party call or a conference call. Or get a dial tone and dial * 3.

The other call is placed on consultation hold.

2. Dial the extension where the call to be picked up is located.

If the call you are picking up is on busy standby queuing for your line, you will already be connected to it now. You do not have to dial an extension for it.

3. After the picked up party answers, press the Conference (CONF) key to join all the parties.

All parties will hear a conference tone to signal that another party has joined the call.

If the picked up party does not want to join the conference, press the Clear key. This disconnects the picked up party and returns you to the original call.

To go back and forth (toggle) between the picked up party and the original call, press the Connect key.

Note: You can also transfer, place on hold, place on consultation hold, or park a call you have picked up. (See “Transfer” on page 33, “Hold” on page 21, “Connect” on page 18, and “Park” on page 24.)

To screen an incoming call before picking it up, put the conference on hold and answer the call. Then return to the conference, pick up the call, and add it to the conference.

Repertory Dialing (Repdial) Keys

This feature lets you set up each repdial (R-) key on your faceplate for one-touch dialing of an extension, outside number, feature access code, or combination of numbers and feature access codes.

To set up a repdial key,

1. When your phone is idle, press the Menu key.
2. Scroll to *Program/Service?* and select it.
3. Select *Change destinations?*.
4. Scroll to *Repdial?* and select it.
5. Press the key you want to set up as a repdial.
6. Enter the dialing sequence you wish to assign to this repdial key.

You can press  to add multiple time delays (the default is 2 seconds for each) to the sequence.

7. Select *Save?*.
8. If you want to set up another repdial key, scroll to *Next entry?* and select it.
9. To end set up, select *SAVED - Exit?*.

OR

Press the Program key. Press the repdial (R-) key that you want to use. Enter the dialing sequence you want to assign to the key. Press the Program key. On your faceplate, label the key with the name of the feature or person that it dials.

To dial using a repdial key,

Press the repdial key.

Saved Number Redial

This feature saves a number that you have dialed. Later, you can redial your saved number.

To save a number you have dialed, while you are still connected with that number,

Select *Save number?* from your OptiGuide display.

Or press the Saved Number Redial (SAV/RDL) key.

Or, while the call is still ringing, dial # 4.

To dial your saved number,

1. Press the Menu key.
2. Select *Speed dial features?*.
3. Scroll to *Saved number redial?* and select it.

OR

Press the Saved Number Redial (SAV/RDL) key, or get a dial tone and dial # 4.

Speaker

The Optiset E Advance telephone has a speaker underneath the handset that you can use for receiving calls or listening to the PhoneMail system. Since the speaker is one-way, you must pick up your handset to speak to the other party.

To answer a call,

Pick up the handset. The blinking status light next to the line key turns on steadily.

To hang up,

Hang up the handset.

Speakerphone

The Optiset E Standard and Advance Plus telephones have a two-way speakerphone, consisting of a speaker and a microphone. You can use either the handset or the speakerphone to make or receive calls. During a conversation, you can use your speakerphone instead of your handset by pressing the Speaker key and hanging up the handset. If you want to switch back to using your handset, pick it up.

To make a call,

Press a line key or the Speaker key to get a dial tone, then dial.

To answer a call,

Press the line key next to the blinking status light.

To hang up,

Press the line key or the Speaker key.

To switch during a call,

If you are using the handset and want to use the speakerphone, press the Speaker key and hang up the handset. If you are using the speakerphone and want to use the handset, pick up the handset.

Station Speed Dialing

Station Speed Dialing lets you assign frequently used dialing sequences (extensions, outside numbers, or feature access codes) to each of ten single-digit codes (0 through 9). You can then dial a single-digit code instead of the entire sequence. You can be set up at the communications server for up to 30 codes, in groups of 10. If you are set up for more than ten, they follow a double-digit scheme (00 through 29).

To set up a station speed code,

1. When your phone is idle, press the Menu key.
2. Scroll to *Program/Service?* and select it.
3. Select *Change destinations?*.
4. Scroll to *Station speed dial?* and select it.
Enter index: will be displayed, for the station speed dialing code.
5. Dial the code you want to use.
Enter new number: will be displayed.
6. Dial the sequence you want the code to dial.
7. Select *Save?*.
8. Select *Exit?*.

OR

Press the Program key. Dial 13. Dial the code you want to use. Dial the sequence you want the code to dial. Select *Save?*. Select *Exit?*.

To dial using a station speed code,

1. When your phone is idle, press the Menu key.
2. Select *Speed dial features?*.
3. Scroll to *Station speed dial?* and select it.
ENTER INDEX: will be displayed.
4. Dial the station speed dialing code.

OR

Press the Station Speed (SPEED) key, and dial the station speed code. Or get a dial tone, dial # 3, and then dial the station speed code.

System Speed Dialing

If the System Speed Dialing feature is set up on your communications server, you can dial frequently called outside numbers (local, long distance, and international) by dialing a code number. Usually these codes are published for an entire company in a special system speed directory. Consult your system administrator if you do not know your system speed numbers. Your company may have up to sixteen system speed lists. You may have access to two of these lists. A number set up for a system speed code can contain an initial Personal Identification Number (PIN), if one is necessary to make outside calls.

To make a system speed call,

1. Press the Menu key.
2. Select *Speed dial features?*
3. Scroll to *System speed dial?* and select it. You may have two system speed dial lists.
ENTER INDEX: will be displayed.
4. Dial the system speed dialing code.

OR

Press the correct System Speed key (SYS-SP1 for the first System Speed list or SYS-SP2 for the second). Or, get a dial tone and dial # 6 1 for the first list or # 6 2 for the second.

Then dial the system speed code.

Transfer

Transfer lets you move a call to another extension or to an outside number if your communications server is set up to do this.

To transfer a call,

1. During a call, select *Start transfer?*
2. Dial the extension, or dial 9 and the outside number. If you want, announce the caller when the party answers.
3. Hang up.

OR

Press the Transfer (TRANSFR) key. Dial the extension, or dial 9 and the outside number. If you want, announce the caller when the party answers. Hang up.

To reconnect,

Before hanging up, scroll to *Release and return?* and select it. This rejoins you to the original call and releases the party you are talking to.

Or scroll to *Toggle/Connect?* and select it. This rejoins you to the original call. Selecting *Toggle/Connect* again returns you to the second party.

Feature Access Codes

To use feature access codes

⇒ Get a dial tone, or press the Transfer key during a call. Dial the feature access code. You may need to press the Connect key to return to your call.

<u>Feature</u>	<u>Access Code</u>
Account Number	* 2
Bad Line Reporting	* 5 6 3
Busy Override	## 7
Buzz	## * 2
Callback Request	# 1
Cancel	## 1
Class of Service	
Restore Primary	* # 5 9 1
Return to Secondary	* # 5 9 0
Com Group Speaker Call	* * 6
Conference	
Remove Last Party	* * * 4
Remove Specific Party	* * 4 1-8
Direct Trunk Select	## 8
Forwarding, Fixed	# 9 0
Cancel	## 9 0
Forwarding, Variable	
All	# 9 1
Busy	# 9 4
Busy/Ring No Answer	# 9 5
External	# 9 2
Internal	# 9 3
Ring No Answer	# 9 6
Cancel	## 9 1
Hold, Private	* * 9
Last Number Redial	## 4
Mailbox Callback Message	
Leave Message	## * 1
Cancel	## * 8
Turn Off Light	* 5 2
Park	* 6
Pickup	
Group	* * 3
Station	* 3
PIN Authorization	* # 5 7
Cancel	* # 5 8
Privacy	# 2
Cancel	## 2
Saved Number Redial	# 4
Speaker Call, Fixed	## * 4
Speaker Call, One-Way	# 8 1
Speaker Call, One-Way Broadcast	# 8 0
Station Hunt	
Prevent	## * 9 3
Allow	## * 9 2
Set Destination	## * 9 0
Clear Destination	## * 9 9
Station Speed Dialing	
Call	# 3
System Hold	* 8 0-9
System Speed-1	# 6 1
System Speed-2	# 6 2
Trace Call	## # 1
Universal Night Answer	* # 3